

To process your return, you'll need to send us both hub assemblies from your product. There are several different models of the Rock 'n Play Sleeper with different product assembly. Please select the instructions that most closely resembles your product. For some models, you'll need a Phillips screwdriver/scissors/wire cutters to remove the hub assemblies.



A. This model does not have a soothing unit or an auto-rock unit. Some models require that you pull the tubes apart to remove the hub assemblies. Follow **steps 1-4 and 9** in the **A** section. Other models have buttons on the metal tubes. You'll need to press the buttons while pulling to remove hub assemblies from the frame and bases. Follow **steps 5-9** in the **A** section.



B. This model includes a soothing unit on the upper frame. It does not have an auto-rock unit.



C. This model includes a soothing unit on the upper frame and an auto-rock unit on the base. The auto-rock controls are located on the soothing unit.



D. This model includes a combined soother-auto-rock unit on the base of the product.



E. This model includes a combined soother-auto-rock unit on the base of the product. This model also has wood bases.

- If your product frame resembles the product shown here, follow the instructions in this section - A.



A

- Steps 1-4 are for models with buttons on the metal tubes.
- Press the fold button on each hub and fold the product.

Note: Your product may have only one fold button.

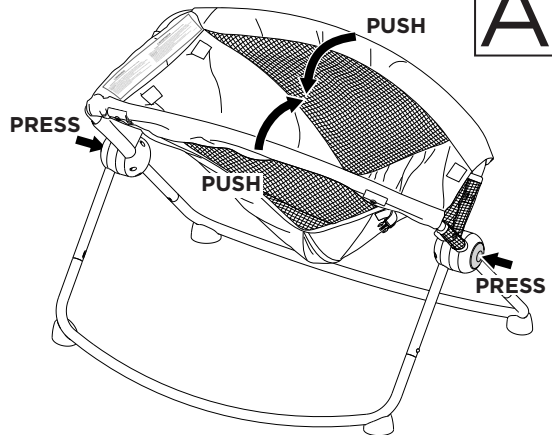

A

1

- Press the buttons on the hub tubes and lift to remove the frame tubes.

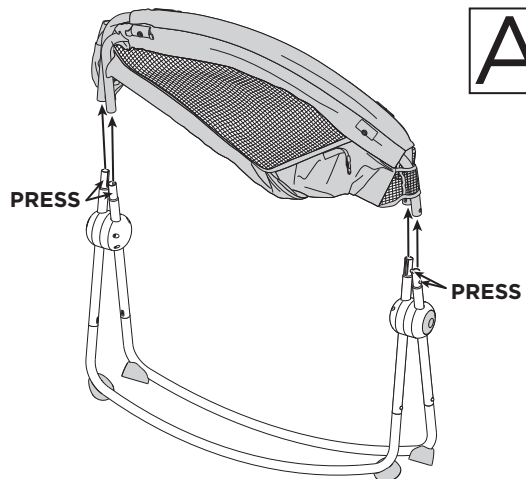

A

2

- Press the button on each hub tube and pull to remove the base from the hub tubes.

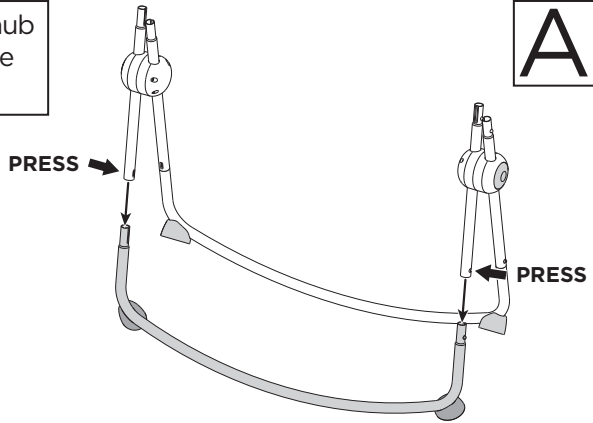

3

- Press the button on each hub tube and pull to remove the base from the hub tubes.

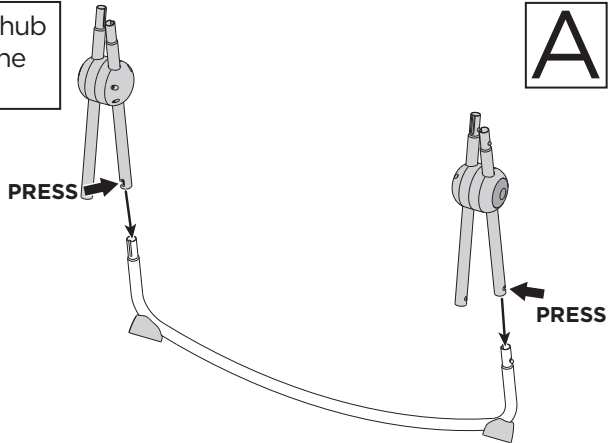

4

- Steps 5-9 are for models without buttons on the metal tubes.
- Press the fold button on each hub and fold the product.

Note: Your product may have only one fold button.

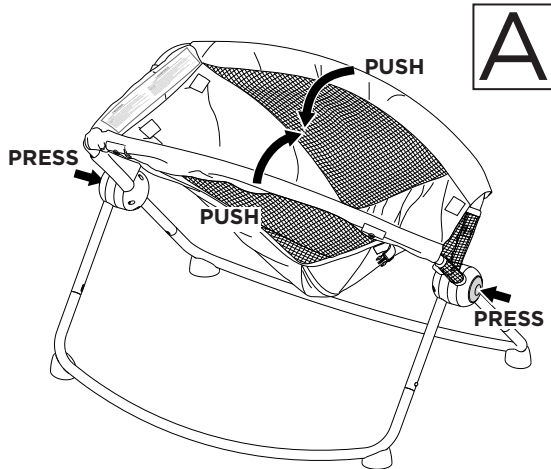

5

- Pull the frame tubes from the hub tubes.

A

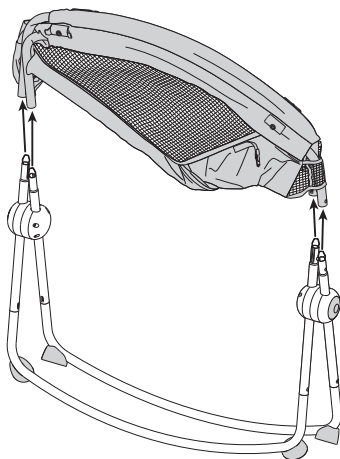

6

- Pull to remove a base from the hub tubes.

A

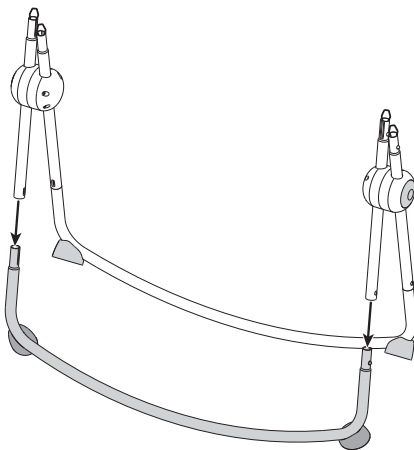

7

- Pull to remove the other base from the hub tubes.

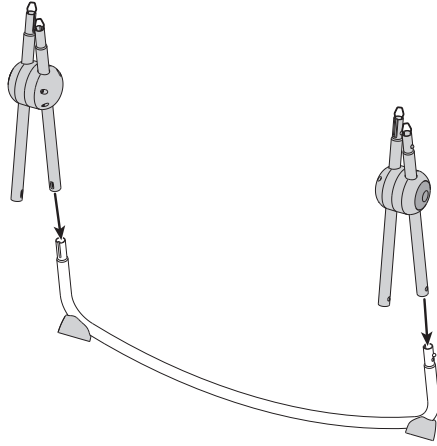

A

8

- Go to the last page for instructions to send the hub assemblies back to Fisher-Price.

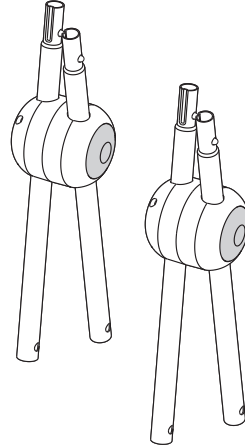

A

9

- If your product frame resembles the product shown here, follow the instructions in this section - B.



B

- Turn your product over and place on a flat surface.
- Carefully pull to remove each base.

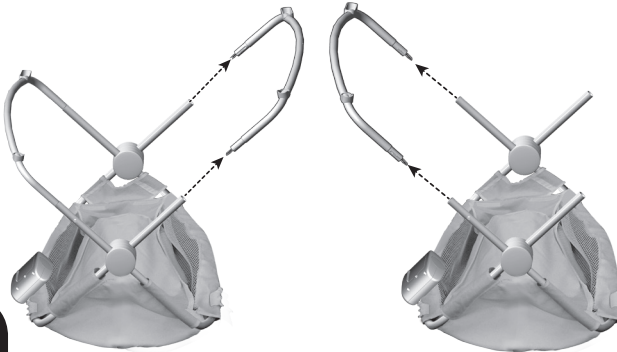

1

B

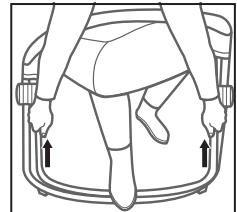

If you're having trouble removing a base, turn the frame upright. Step on the base and pull the hub tubes.

- Turn the product upright.
- Press the fold button on the hub and fold the product.

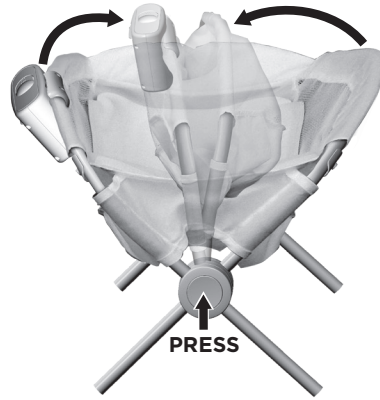

B

2

- Pull to remove the the frame tubes from the hub assemblies.

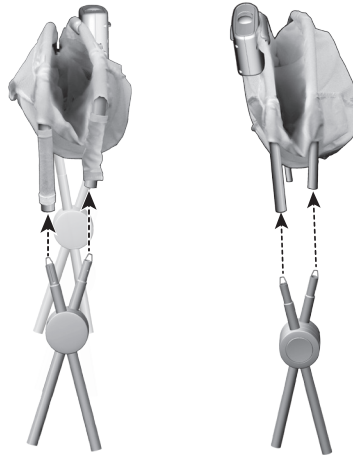

B

3

- Go to the last page for instructions to send the hub assemblies back to Fisher-Price.

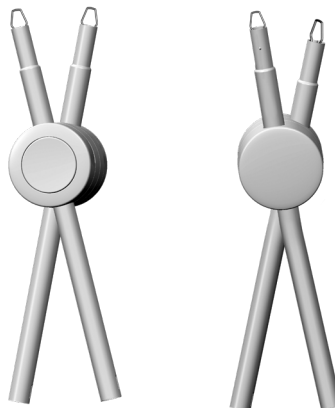

B

4

- If your product frame resembles either product shown here, follow the instructions in this section - C.

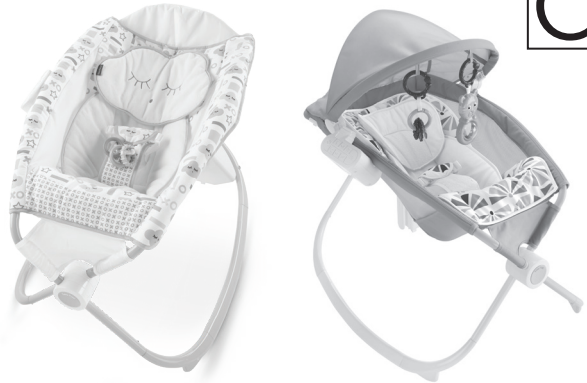

- Turn the product face down on a flat surface.
- Using a Phillips screwdriver, loosen and remove the screw in the auto-rock unit.

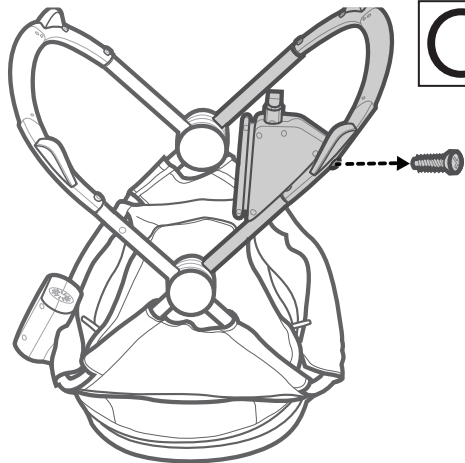

1

- Press the buttons on the hub tubes and pull to remove the bases.

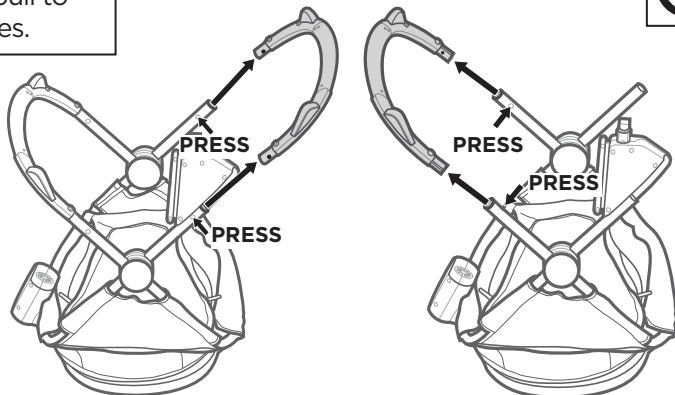

2

- Loosen and remove the screws in the hub tube.

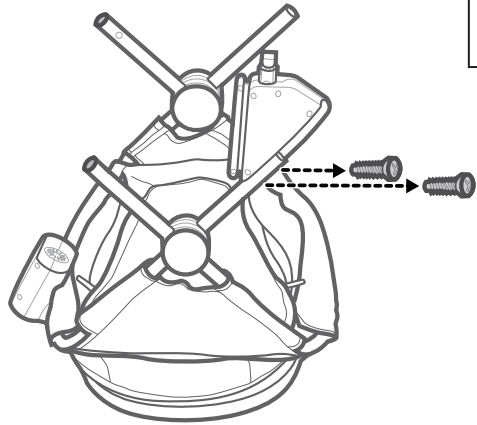

3

- Pull the auto-rock unit from the hub tube.
- Using scissors or wire cutters, cut the cord extending from the auto-rock unit.

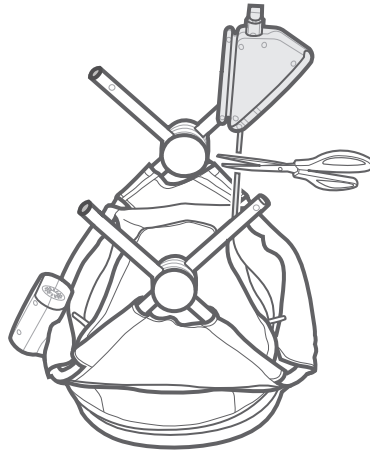

4

- Turn the product upright.
- Press the fold button on the hub and fold the product.

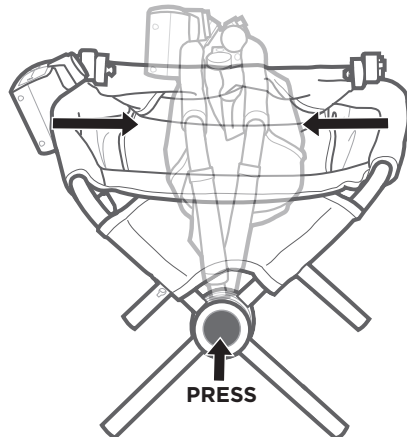

5

- Press the button on the frame tubes and lift the frame tubes from the hub tubes.

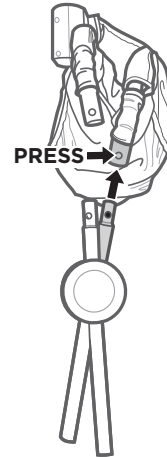
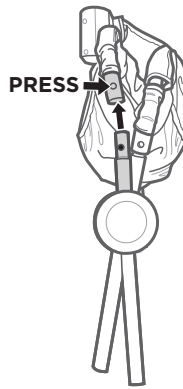

C

6

- On the other side of your product, press the button on the frame tubes and lift the frame tubes from the hub tubes.

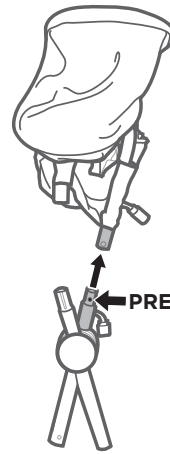
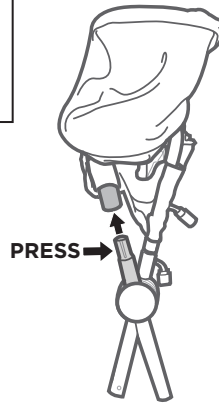

C

7

- Go to the last page for instructions to send the hub assemblies back to Fisher-Price.

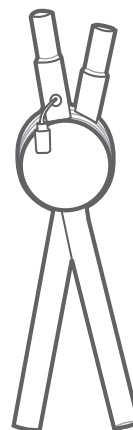
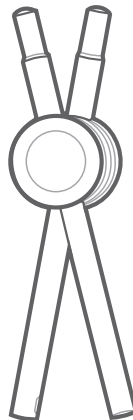

C

8

- If your product frame resembles the product shown here, follow the instructions in this section - D.



D

- Using a Phillips screwdriver, loosen and remove the screws in the auto-rock unit retainer.
- Remove the auto-rock unit and the retainer from the frame.



D

1

- Turn your product face down. Press the buttons on the hub tubes and pull to remove the bases.

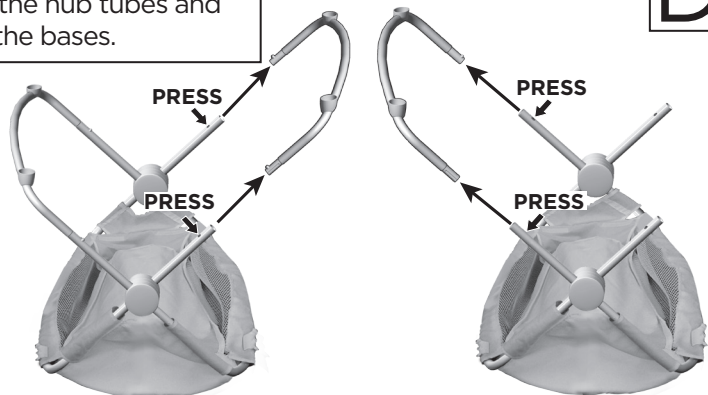

D

2

- Turn the product upright.
- Press the fold button on the hub and fold the product.

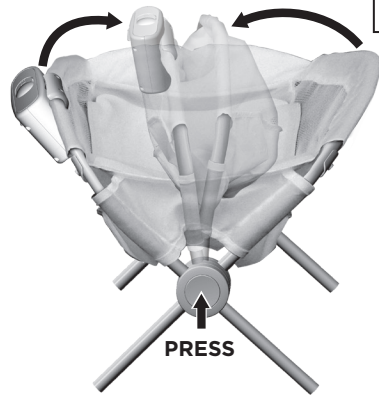

3

- Press the buttons on the frame tubes and lift the frame tubes from the hub tubes.

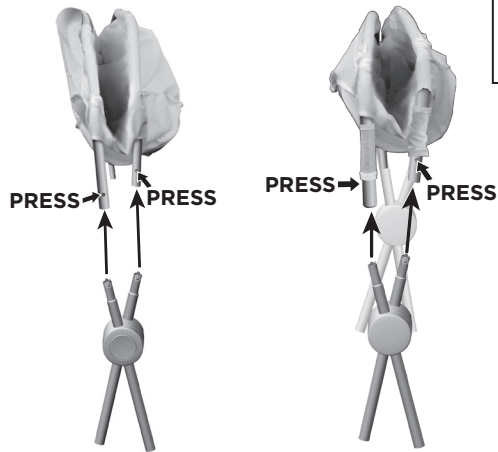

4

- Go to the last page for instructions to send the hub assemblies back to Fisher-Price.

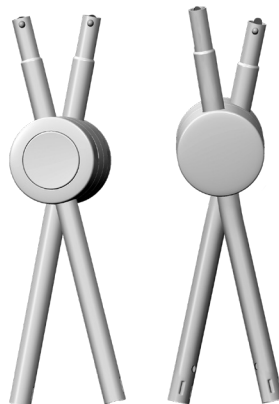

5

- If your product frame resembles the product shown here, follow the instructions in this section - E.

E



- Using a Phillips screwdriver, loosen and remove the screws in the auto-rock unit retainer.
- Remove the auto-rock unit and the retainer.

E

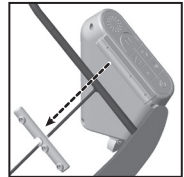

1

- Pull to remove the bases from the hubs.

E

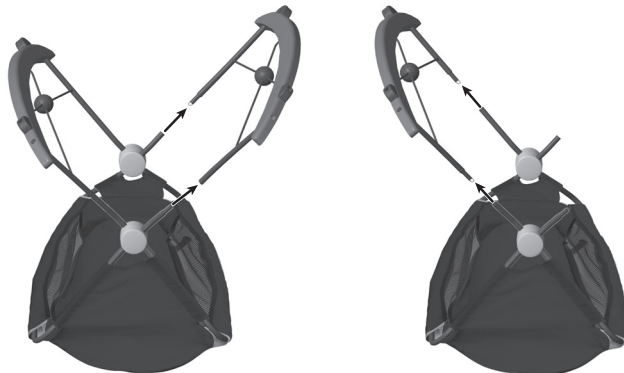

2

- Turn the product upright.
- Press the fold button on the hub and fold the product.

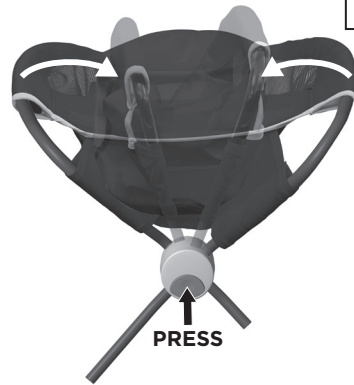
E**3**

- Pull to remove the frame tubes from the hub tubes.

E**4**

- Go to the last page for instructions to send the hub assemblies back to Fisher-Price.

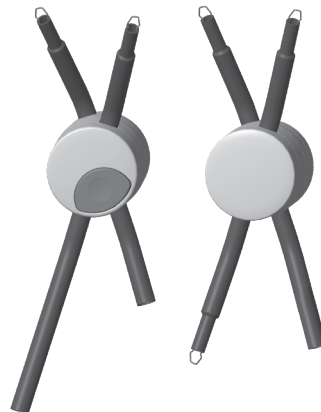
E**5**

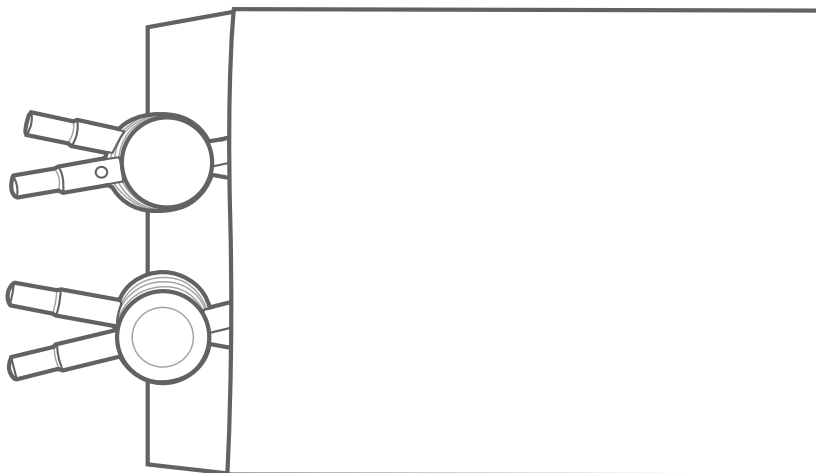

- Send back both hub assemblies and the original purchase receipt if you have it. If you do not have the original sales receipt, please write the day and month of the purchase on one of the hubs.
- Attach the pre-paid shipping label to the package and send back to Fisher-Price.
- If you have any questions please don't hesitate to call us at 866-812-6518, 9 AM - 6 PM EST Monday through Friday.